

Rz3.2

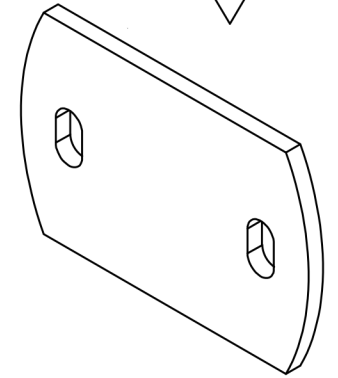

100.0155		1:1	A0
		SS304	
		0.41kg	2019.9.29