

Rz3.2

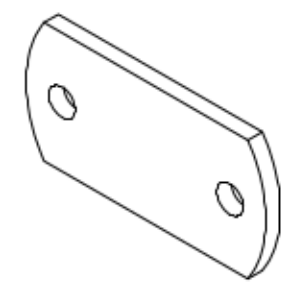
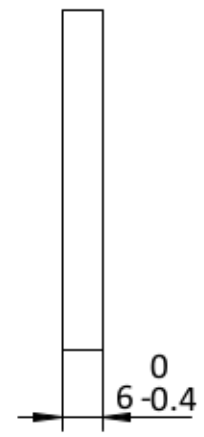
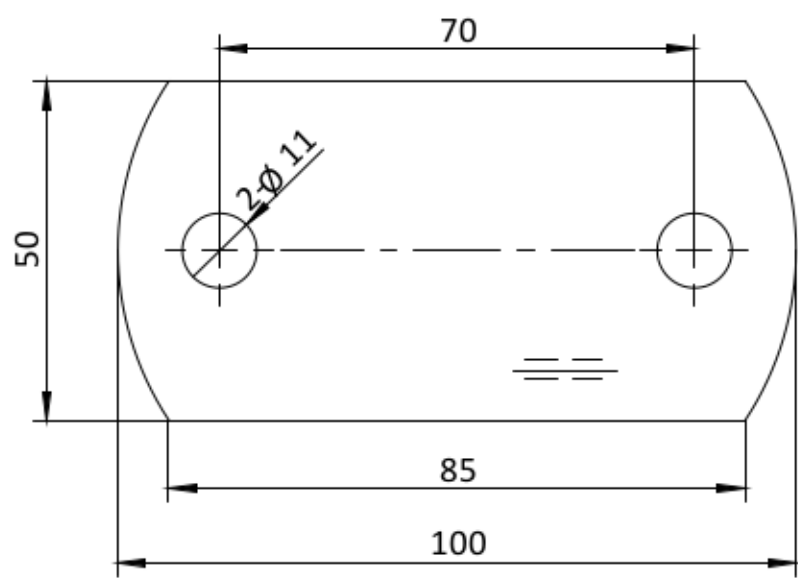

100.0145		1:1	A0
		SS304	
		0.22kg	2019.9.27